

A	B	C	D	E	F	G	H	I
X2	X2		X2	X2	X2	X2		X2

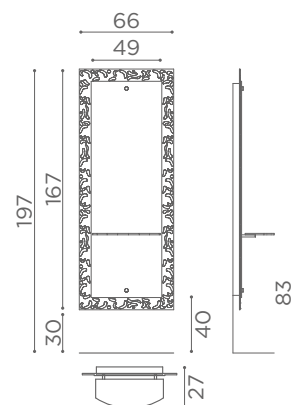

Lyon/Fiji/Lunar

SCHEMA FISSAGGIO LED ASSEMBLY INSTRUCTIONS, LED LIGHT

BIADESIVO

**DOUBLE-SIDED
TAPE**

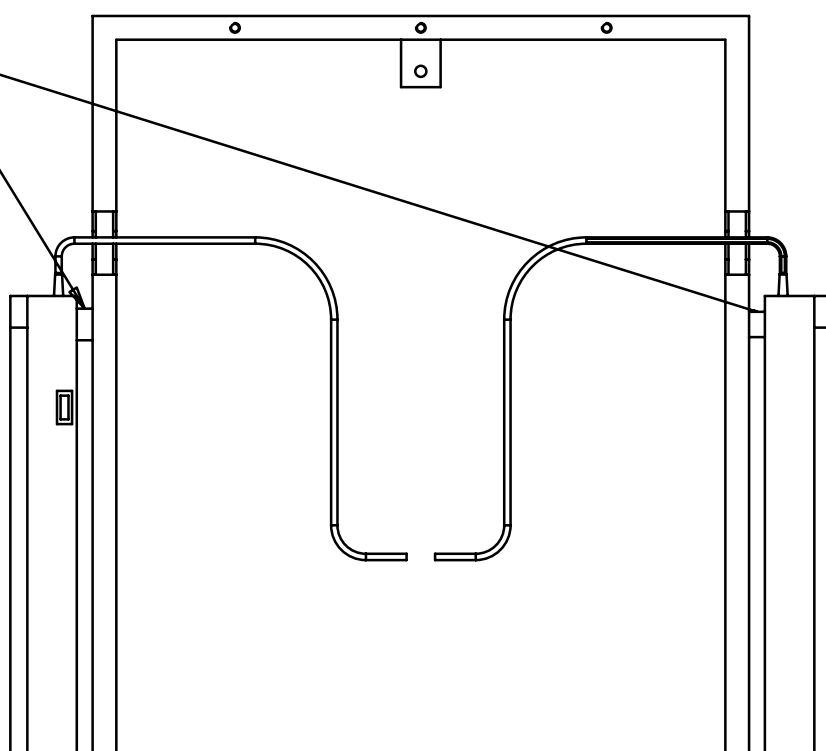

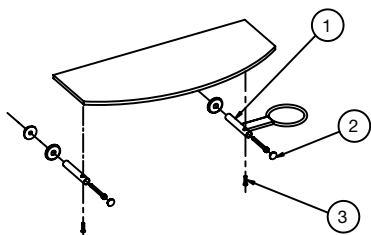

GLASS -01

FIJI	MI/030
LYON	MI/050
LYON ISLAND	MI/052
PLATINUM	MI/150
PRECIOUS	MI/320
LUNAR	MI/370
LUNAR ISLAND	MI/372
COSMOS	MI/420
COSMOS ISLAND	MI/422
SPACE	MI/440
TREASURE	MI/450

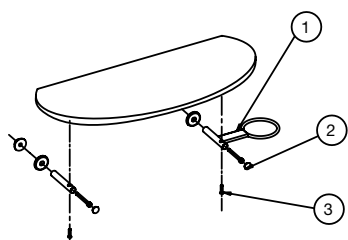

**BLACK
GLASS -02**

FIJI	MI/030
LYON	MI/050
LYON ISLAND	MI/052
PLATINUM	MI/150
PRECIOUS	MI/320
LUNAR	MI/370
LUNAR ISLAND	MI/372
COSMOS	MI/420
COSMOS ISLAND	MI/422
SPACE	MI/440
TREASURE	MI/450

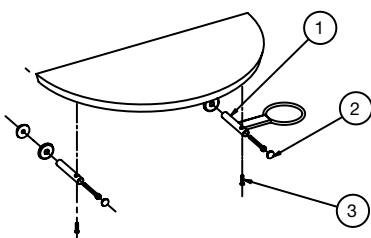

**ROUND
ALUMINIUM -05**

FIJI	MI/030
LYON	MI/050
LYON ISLAND	MI/052
PLATINUM	MI/150
PRECIOUS	MI/320
LUNAR	MI/370
LUNAR ISLAND	MI/372
COSMOS	MI/420
COSMOS ISLAND	MI/422
SPACE	MI/440
TREASURE	MI/450

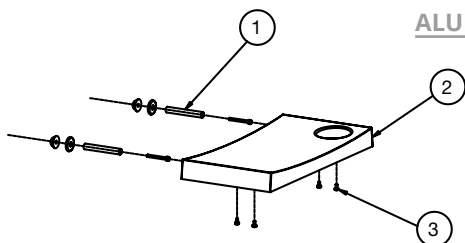

ALUMINIUM -06

FIJI	MI/030
LYON	MI/050
LYON ISLAND	MI/052
PLATINUM	MI/150
PRECIOUS	MI/320
LUNAR	MI/370
LUNAR ISLAND	MI/372
COSMOS	MI/420
COSMOS ISLAND	MI/422
SPACE	MI/440
TREASURE	MI/450

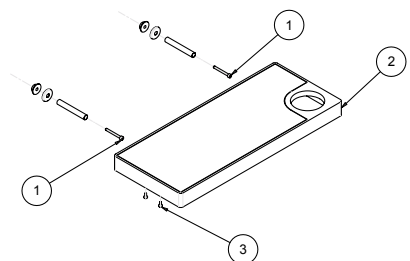

**ALUMINIUM
+ MIRROR -07**

FIJI	MI/030
LYON	MI/050
LYON ISLAND	MI/052
PLATINUM	MI/150
PRECIOUS	MI/320
LUNAR	MI/370
LUNAR ISLAND	MI/372
COSMOS	MI/420
COSMOS ISLAND	MI/422
SPACE	MI/440

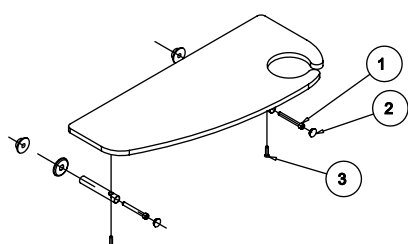

GLASS -02

NEW YORK MI/520-10
NEW YORK ISLAND MI/522-10

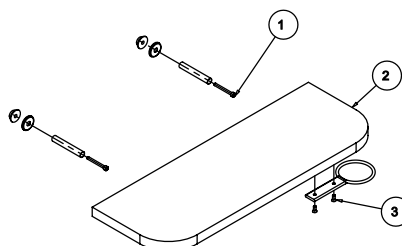

**VINTAGE
WOOD**

NEW YORK MI/510-09
NEW YORK ISLAND MI/512-09